

# AVK **N1100**

---

## QUICK START GUIDE

NETWORK KEYBOARD

Please read this instruction carefully for correct use of the product and preserve it for reference purposes.

Thank you for purchasing our product. There may be several technically incorrect places or printing errors in this manual. The updates will be added into the new version of this manual. We will readily improve or update the products or procedures described in the manual. The content is subject to change without notice.

#### Note

- LCD display can be easily damaged. Please do not press or exposure in sunshine for a long time.
- The joystick can be easily damaged. If it needs to be repaired, please wrap and ship it by using original or safety packaging.
- This keyboard should be used in certain range of temperature and humidity, referring the specifications.
- Please connect the keyboard correctly as this manual requires.

Items	Quantity	Note
Network keyboard	1	/
DC12V power adapter	1	Input : AC100-240V
Power cable	1	/
CD	1	Included user manual

# Table of Contents

<b>1 Introduction .....</b>	<b>1</b>
1.1 Introduction .....	1
1.2 Rear Panel Instructions .....	1
1.3 Front Panel Instructions .....	2
1.4 Rules of Key Press .....	3
1.5 Joystick Control .....	4
<b>2 Setup .....</b>	<b>5</b>
2.1 Startup the Keyboard .....	5
2.2 System Setup .....	5
2.2.1 Password Setup .....	5
2.2.2 Keypad ID Setup .....	6
2.2.3 Network Setup .....	6
2.2.4 Default Setup .....	7
2.2.5 Question Setup .....	7
2.2.6 Playback Set .....	7
2.3 PTZ Setup .....	7
2.4 Language Setup .....	7
2.5 Test .....	8
<b>3 PTZ Mode .....</b>	<b>9</b>
3.1 Mode Setup .....	9
3.2 PTZ IP Setup .....	9
3.3 PTZ Operation .....	9
3.4 PTZ Shift .....	10
<b>4 Decoding .....</b>	<b>11</b>
4.1 Screen Display Mode .....	11
4.2 Camera->Monitor.....	11
4.3 Camera Group-> Window .....	12
4.4 Camera Group->Monitor .....	12
4.5 Call Layout.....	13
4.6 Set and Call Macro .....	13
4.7 Alarm Window Setup .....	14
4.8 PTZ Control .....	14
4.8.1 Move or Stop .....	14
4.8.2 Set or Call Preset .....	15
4.8.3 Call or Stop Cruise/Track .....	15

4.8.4 Focus +/- .....	16
4.8.5 Zoom +/- .....	16
4.8.6 Iris +/- .....	16
4.8.7 Start or Stop Auto Scan .....	17
4.8.8 Enable/Disable Light .....	17
4.8.9 Enable/Disable Wiper .....	17
4.9 Record Playback .....	18
4.9.1 Start Playback .....	18
4.9.2 Pause Playback .....	18
4.9.3 Play the Previous 30s .....	18
4.9.4 Play the Next 30s or Frame .....	18
4.9.5 Stop Playback .....	18
<b>5 Others .....</b>	<b>19</b>
5.1 View Information .....	19
5.2 Lock .....	19
<b>6 Web .....</b>	<b>20</b>
6.1 Web Access .....	20
6.2 Upgrade .....	21
<b>7 Specifications .....</b>	<b>22</b>
<b>Appendix .....</b>	<b>23</b>

# 1 Introduction

## 1.1 Introduction

This network keyboard is fully compatible with the NVMS/CMS of our company, which can control camera, screen, monitor, etc. It's easy to use for users due to the menu display on the screen.

## 1.2 Rear Panel Instructions



Name	Description
PW	When the network keyboard is working, the power indicator turns red.
LINK	The network status indicator
RS232	Internal testing port
RJ45	RJ45 network port
RS485	Connect speed dome or the RS485 port of the DVR; TA connects to RS485+; TB connects to RS485-
DC-12V	DC12V power input
WIFI	Unavailable
	Grounding

### 1.3 Front Panel Instructions



Name	Functions
SETUP	Local setup, such as keyboard ID, network setup.
INFO	Local information, such as ID, model, network parameters.
SHIFT	Auxiliary key for main interface shift or PTZ shift or security questions shift.
LOCK	Lock keyboard; press this key to lock the keyboard.
MON	Set the output (monitor).
WIN	Set the window of the current output.
CAM	Select the camera.
MULT	Set the screen display mode of the current output.
MON-G	Select the output group (monitor group).
CAM-G	Select the input group (camera group).
LAYOUT	Call scheme.
AUDIO	Enable/disable audio of the selected window.
▶	Play
⏸	Pause
■	Stop
●	Enable / disable manual record.
◀	Jump to the previous 30 seconds from the current playing time point by clicking this button.
▶	When the record is being played in the playback mode, it will jump to the next 30 seconds from the current playing time point by clicking this button; when the record is on hold, the system will play the next frame by clicking this button.

MACRO	Macro function key; set and call macro instructions.
ALARM	Set the first image of the current output as an alarm large image.
0-9	Input the number/ alphabet /symbol.
ESC	Cancel the number/alphabet; cancel the operation; return to the previous menu.
ENTER	Enter menu or confirm to save the current settings.
PRESET	Set and call the preset.
CRUISE	Call or stop the cruise.
TRACK	Call or stop the track.
AUTO	Enable or disable the auto scan.
FOCUS+	Click it to have long focus.
FOCUS-	Click it to have short focus.
ZOOM+	Zoom in
ZOOM-	Zoom out
IRIS+	Iris increases
IRIS-	Iris decreases
WIPER	Enable or disable wiper.
LIGHT	Enable or disable light.

#### 1.4 Rules of Key Press

Double press--- the interval time between two presses less than 2 seconds. It mainly uses to switch the alphabet.

For example, press 2 twice to input A; press 2 three times to input B. Please see appendix for the detailed rules of key press.







When selecting or switching the operating object, it usually starts with the number key and ends with the corresponding functional key. Take the following as examples.

1+MON (press 1 and then press MON)-- select 1 output

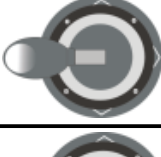
123+CAM (press 1, 2, 3 and then press CAM)-- select 123 output

10+PRESET (press 1, 0 and then press PRESET)-- call preset 10

## 1.5 Joystick Control

Figure	Operation	Function
	Up	In PTZ control mode: control the speed dome to move up.
	Down	In PTZ control mode: control the speed dome to move down.
	Left	In PTZ control mode: control the speed dome to move left.
	Right	In PTZ control mode: control the speed dome to move right.
	Upper Left	In PTZ control mode: control the speed dome to move towards upper left.
	Upper Right	In PTZ control mode: control the speed dome to move towards upper right.
	Lower Left	In PTZ control mode: control the speed dome to move towards lower left.
	Lower Right	In PTZ control mode: control the speed dome to move towards lower right.
	Rotate Left	Zoom in
	Rotate Right	Zoom out



## 2.1 Startup the Keyboard

First connect the network cable to the keyboard and then connect the power. After the device starts, please input the default password (8888) and then press "Enter" key to go to main interface (see left figure). Press "Setup" key to go to the system setup menu (see right two figures).

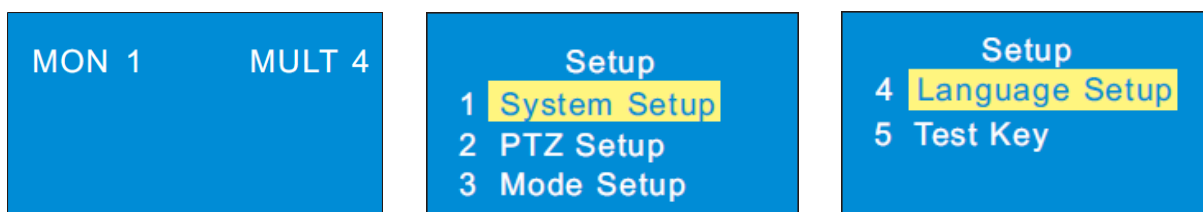

## 2.2 System Setup

All system setup menus are as follow. You can move the joystick up or down to see all system setup menus.

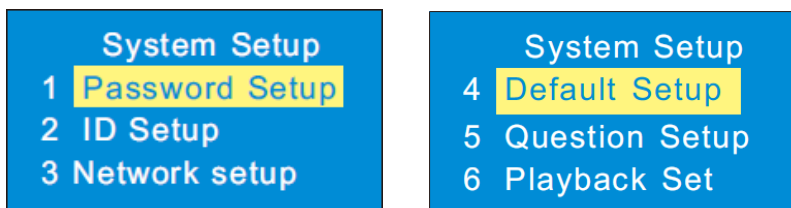

### 2.2.1 Password Setup

Select the password setup menu and press "Enter" key to go to password setup.

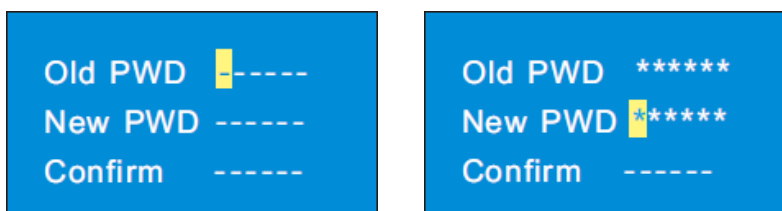

Input the old password by moving the joystick right one by one (the default password is 8888). Select the new password by moving the joystick down and then input the new password as the above mentioned method. Finally confirm the new password and press "Enter" key to save the settings. If you want to change the inputted number, please move the joystick to current position to change the current number. If you want to cancel the inputted number, you can press "0" for two times. Press "Enter" key to save the new password. Press "Cancel" key to return to the previous menu.

## 2.2.2 Keypad ID Setup

Select the keypad ID setup menu and press "Enter" key to go to keypad ID setup.

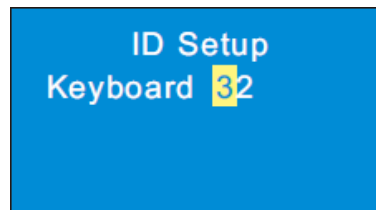
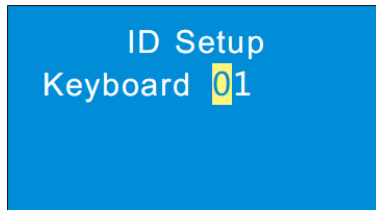

The effective value of the ID is from 1 to 32.

To set keypad ID, press digital number and enter key (eg. press 32 and then press "Enter" to set the keypad ID at 32).

## 2.2.3 Network Setup

Network setup includes local IP setup, PLAT IP setup and PTZ IP setup. The local IP address, the PLAT IP address and PTZ IP address must be in the same local network segment.

### ▶ Local IP Setup

Select "Local IP Setup" and press "Enter" to go to local IP setup. You can set the local IP address, subnet mask, default gateway, DNS server, alternate DNS and HTTP port.

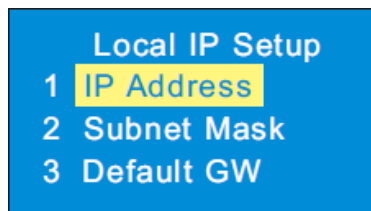

- ❖ IP address: Select IP address and press "Enter" to set the IP address. The default IP address is 192.168.1.201.

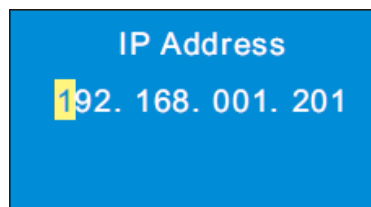

**Tips: Move the joystick right to set the IP address. Press "Enter" to save the settings and return to the previous menu.**

- ❖ Subnet mask: select subnet mask and press "Enter" to set subnet mask. The default subnet mask is 255.255.255.0.

- ❖ Default GW: the default gateway is 192.168.1.1. Please input it according to the actual network.

- ❖ DNS server: the default DNS server is 8.8.8.8. Please input it according to the actual network.

- ❖ Alternate server: the default alternate server is 4.4.4.4. Please input it according to the actual network.
- ❖ HTTP port: the default http port is 4000. Please input it according to the actual network.

### ▶ **PLAT IP Setup**

Select "PLAT IP setup" and press "Enter" to set the PLAT IP address.

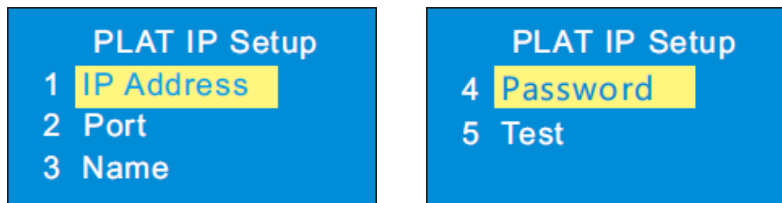

- ❖ IP address: input the IP address of the TV Wall Client of the ECMS/NVMS 5000.
- ❖ Port: the default port is 56789. The port must be the same with that of the TV Wall Client.
- ❖ Name and password: the name and password must be the same with that of the TV Wall Client.
- ❖ Test: To test if the keyboard is online.

### ▶ **PTZ IP Setup**

Please see [3.2 PTZ IP Setup](#) for details.

## **2.2.4 Default Setup**

Select it and press "Enter" to restore the system settings to the default factory settings.

## **2.2.5 Question Setup**

Select it and press "Enter" to set the security question which can reset your password.

## **2.2.6 Playback Set**

**Only some models support this function.**

Select it and press "Enter" to set instant playback time when using the network keyboard to control video output of the decoder.

## **2.3 PTZ Setup**

Select it and press "Enter" to go to the settings of PTZ to set the speed of the PTZ.

## **2.4 Language Setup**

Select it and press "Enter" to switch the language between English and Chinese. Some models also support Polish, Hungarian, Italian and so on.

## 2.5 Test

Select it and press "Enter" to test if the button is available. User can also check if the silk-screen on the button and display on the screen is consistent which is not use for operating equipment.

## 3.1 Mode Setup

Platform mode and PTZ mode are optional. Select PTZ mode and press "Enter" to select. Some models may connect 256 PTZs and control PTZs which support ONVIF.

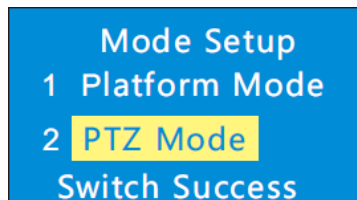

**Tips: Some models support a default mode (platform mode or PTZ mode), namely it will restore to the last working mode after restart. In PTZ mode, you only need to select operational PTZ, do not need to choose the output and the window, and the other operations are similar to the platform modes.**

## 3.2 PTZ IP Setup

Go to Network Setup to select "PTZ IP Setup" and press "Enter" to go to select the PTZ. Then set the IP address, port, name, password of the PTZ selected.

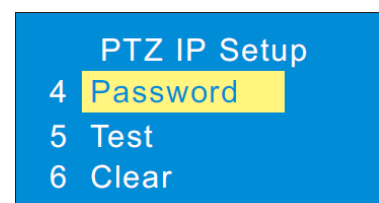
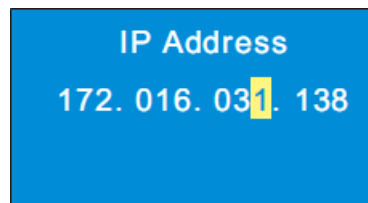
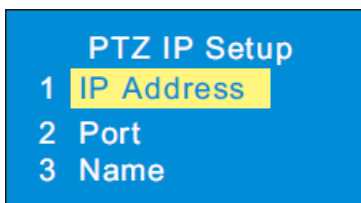

- ❖ IP address: input the IP address of the PTZ. This IP address must be in the same local network segment with the local IP address of the network keyboard.
- ❖ Port: the default port is 80 (the http port of the PTZ).
- ❖ Name and password: the name and password must be the same with that of the PTZ.
- ❖ Test: To test if the PTZ is online.
- ❖ Clear: To clear the information of the PTZ (Only some models support this function).

## 3.3 PTZ Operation

After setting up the IP address, port, name and password of the PTZ you can operate the PTZ by joystick or PTZ controller keys. Please see [4.8 PTZ Control](#) for more details.

### 3.4 PTZ Shift

Some models support shifting the PTZs by pressing "Number plus SHIFT".

Select other PTZ and setup the IP address, port, name and password. Please see [3.2 PTZ IP Setup](#) for more details.

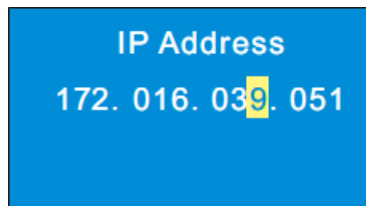
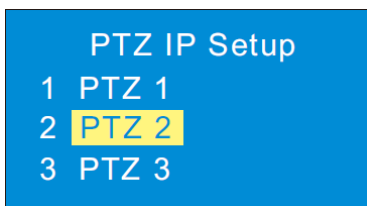

Press "SHIFT" to switch the PTZs of which the IP address is setup well.

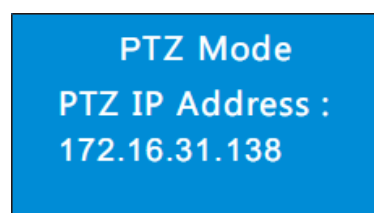
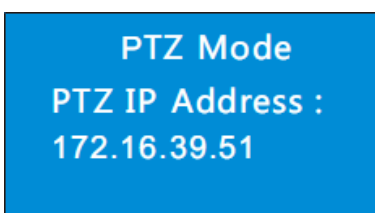

Before using the network keyboard to control video output of the decoder, please make sure the authentication server, media transfer server, storage server, alarm server and TV wall server of the ECMS/NVMS5000 all starts and they are all connected well with the decoder.

**Note: Here we only take platform mode as example. If you choose the same monitor(window or camera), you can skip the steps of inputting the monitor(window or camera).**

## 4.1 Screen Display Mode

At present, it is only to support 1/4/9/16 screen display mode.

### To set the screen display mode

1. Input the monitor number (the output number) and then press "MON" key to call this output. For example, input 1 and then press "MON" to select No. 1 output.
2. Input the number of the screen display mode and then press "MULT" to set the screen display mode of the above output. For example, input 9 and then press "MULT" to set at 9 screens display mode.

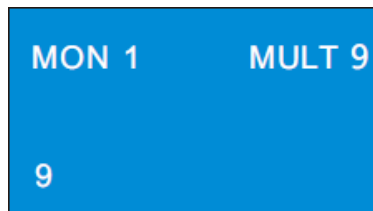

**Note:** \* The effective value is from 1 to 999. The maximum number of the screen display mode of TV wall client is 16 screens. As a result, the maximum of 16 screens can be called when controlling TV wall client.

\* When controlling the output, the number of the output of the TV wall client must be set in advance. The way to set the output number is to drag the output window to the right hand in the TV wall client interface and then right click the top of the small window to pop up a menu. Then go to TV wall client -> Setup -> Channel-NO. Mapping to change the output number.

## 4.2 Camera -> Monitor

Select the input signal (camera) to the designated output and window.

1. Select monitor (output). For example, input 1 and then press "MON" to select NO.1 monitor.
2. Select screen display mode. For example, input 4 and then press "MULT" to select 4 screens display mode.
3. Select window. For example, input 3 and then press "WIN" to select NO. 3 window.
4. Select camera. For example, input 3 and then press "CAM" to select NO. 3 camera.

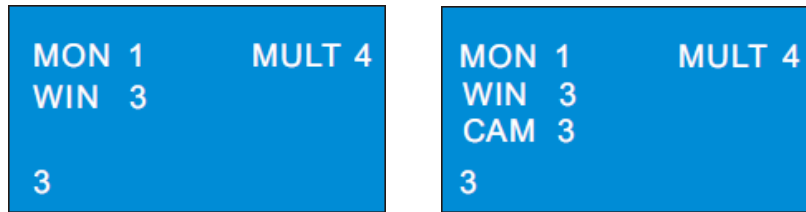

As a result, you will see the image of NO.3 camera in NO.3 window and 4 screens display mode will be seen in NO.1 monitor.

You can check the relationship between camera number and channel from ECMS/NVMS5000 (go to TV wall client -> Setup -> Channel-NO. mapping).

**Note:** The effective value of the camera is form 1 to 999999. When NO. zero camera is inputted, it means to delete the input from the designated window. The effective value of the window is from 1 to the number of the current all split screens.

#### 4.3 Camera Group -> Window

1. Select monitor (output). For example, input 1 and then press "MON" to select NO.1 monitor.
2. Select screen display mode. For example, input 4 and then press "MULT" to select 4 screens display mode.
3. Select window. For example, input 3 and then press "WIN" to select NO. 3 window.
4. Select camera group. For example, input 2 and then press "CAM-G" to select NO. 2 camera group.

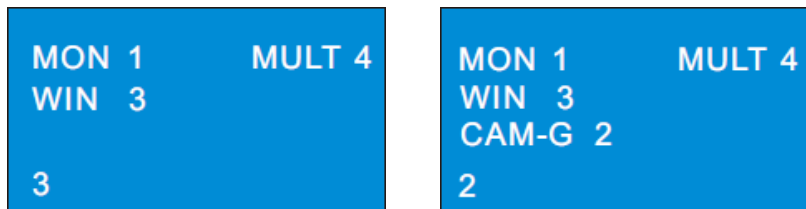

**Camera group settings:** go to TV wall client -> Setup -> Create Channel Group to create channel (camera) group and dwell time. Then click "Modify or Delete Channel Group" to add the channel for this camera group. The effective value is form 1 to 999999.

#### 4.4 Camera Group->Monitor

Select the output group (camera group) to the designated output monitor. If the camera quantity of the camera group (m) is equal or less than the quantity of the output window (n), the camera output will be all displayed in the current screen display mode. If m is greater than n, the previous n cameras will be output to the n windows in sequence and then the remaining n cameras will be output to the n windows in sequence after the dwell time is up until all cameras of the camera group is displayed. After that, all cameras of the camera group will be played again like that. The setting steps are as follow.



1. Select monitor (output). For example, input 1 and then press "MON" to select NO.1 monitor.
2. Select screen display mode. For example, input 4 and then press "MULT" to select 4 screens display mode.
3. Select camera group. For example, input 2 and press "CAM-G" to select NO. 2 camera group.

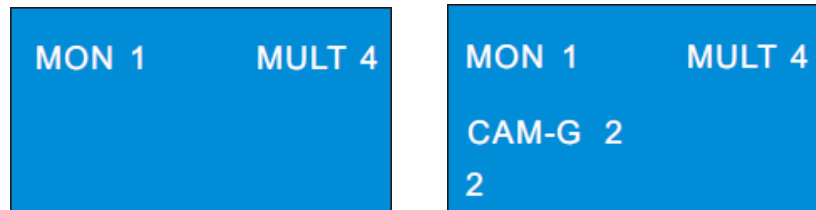

#### 4.5 Call Layout

You may set the input or output scheme in advance and then call it through network keyboard. For example, input 1 and then press "LAYOUT" to select NO.1 scheme.

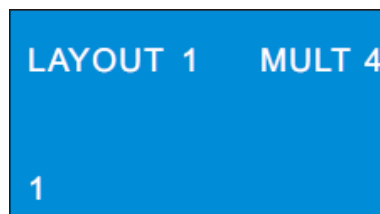

**To set scheme:** go to TV wall client and then drag the outputs to the right window. Next, set the screen display mode and add the cameras for all outputs. Finally click "Save" to save the scheme. The scheme will be saved at the bottom of the TV wall client. You can call the saved scheme by inputting number and pressing "LAYOUT" on the network keyboard. The effective value is form 1 to 9999.

#### 4.6 Set and Call Macro

Macro is used to provide a shortcut to execute a group of consecutive actions. A macro includes a maximum of 50 key orders. Macro instructions are saved in the keyboard. The setting steps of macro are as follow.

1. Input the digital number and then press and hold "MACRO" key to set macro. For example, input 2 and press "MACRO" key for more than 2 seconds to set NO.2 macro.
2. Input a series of keys. For example, input 1 and press "MON", input 2 and press "WIN", input 2 and press "CAM".
3. Press "Enter" to complete the macro setup.



Set Macro 2

Input digital number and then press "MACRO" to call NO. 2 macro instruction. Moving the joystick down can display all information of this macro instruction. Press "ESC" key of the keyboard to return to the main menu of the keyboard.

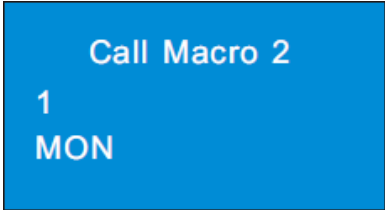

Call Macro 2  
1  
MON



2  
WIN  
2



2  
CAM  
END

#### 4.7 Alarm Window Setup

You can set the designated window as an alarm window. The designated window is NO.1 window by default, which cannot be modified in case the designated window set by the user is not existence. The setting steps are as follow.

1. Select the output. For example, input 1 and press "MON" to select NO.1 monitor.
2. Press "ALARM" key to set the designated NO.1 window (channel) as alarm window. If the current NO.1 window (channel) has been set as alarm window, the alarm window will be cancelled by the above operation.

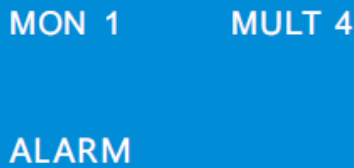

MON 1      MULT 4  
  
ALARM

#### 4.8 PTZ Control

Only when the PTZ is input to the window and there is not sequence display in this window, can the PTZ control be effective—that is, the camera input to this window must be a PTZ device (or speed dome).

##### 4.8.1 Move or Stop

The setting steps are as follow.

1. Select the output (monitor). For example, input 1 and press "MON".
2. Select the window. For example, input 3 and press "WIN".
3. Control the speed dome/PTZ by moving the joystick. When moving the joystick back to the original place, the speed dome stops moving.

**Note:** The camera input to the above example of NO. 3 window must be a PTZ device (or speed dome), or the calling is invalid. The effective value of the preset is from 1 to 255. The effective value of the cruise is from 1 to 8 and. The effective value of track is from 1 to 4. If the calling number is beyond the range, an invalid tip will be displayed on the screen.

#### 4.8.2 Set or Call Preset

##### To set preset

1. Select the output. For example, input 1 and then press "MON".
2. Select the window. For example, input 3 and then press "WIN".
3. Set the position of the preset by moving joystick.
4. Press the digital number on the keyboard to select the number of preset. Then press "PRESET" for more than 2 seconds to set the preset. For example, input 1 and then press "PRESET" for more than 2 seconds to set the NO.1 preset.

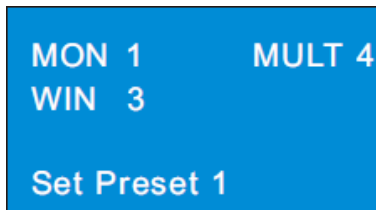

##### To call preset

1. Select the output. For example, input 1 and press "MON".
2. Select the window. For example, input 3 and press "WIN".
3. Select the preset. For example, input 1 and press "Preset".

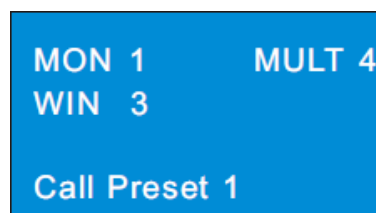

#### 4.8.3 Call or Stop Cruise/Track

##### To call cruise/track

1. Select the output. For example, input 1 and press "MON".
2. Select the window. For example, input 3 and press "WIN".
3. Select the cruise/track. For example, input 1 and press "CRUISE/TRACK".

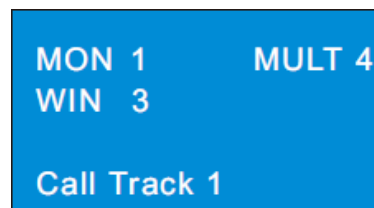
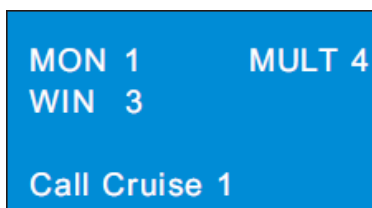

**To stop cruise/track**

1. Select the output. For example, input 1 and press "MON".
2. Select the window. For example, input 3 and press "WIN".
3. Select the cruise/track. For example, input 0 and press "CRUISE/TRACK" or press "CRUISE/TRACK" directly.

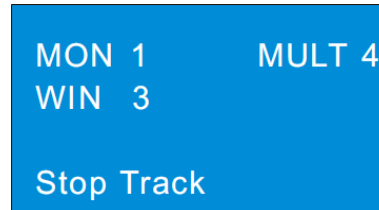
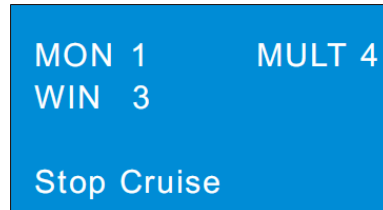
**4.8.4 Focus +/-****To set focus +/-**

1. Select the output. For example, input 1 and press "MON".
2. Select the window. For example, input 3 and press "WIN".
3. Press "FOCUS+" or "FOCUS-".

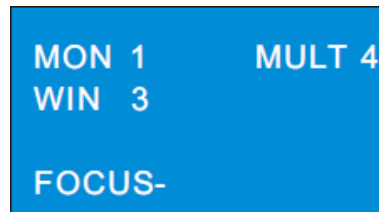
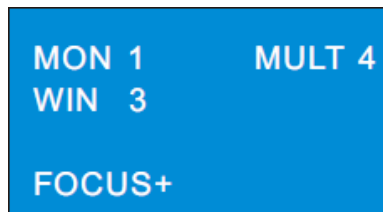
**4.8.5 Zoom +/-****To set zoom +/-**

1. Select the output. For example, input 1 and press "MON".
2. Select the window. For example, input 3 and press "WIN".
3. Press "ZOOM+" or "ZOOM -".

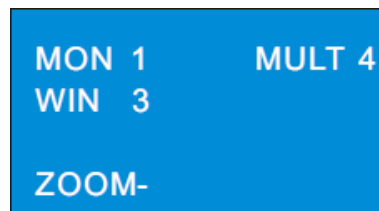
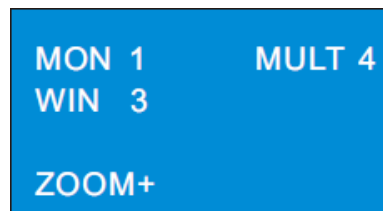
**4.8.6 Iris +/-****To set iris +/-**

1. Select the output. For example, input 1 and press "MON".
2. Select the window. For example, input 3 and press "WIN".
3. Press "IRIS+" or "IRIS -".

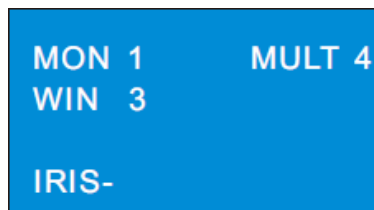
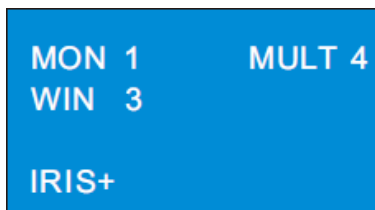

#### 4.8.7 Start or Stop Auto Scan

##### To start or stop auto scan

1. Select the output. For example, input 1 and press "MON".
2. Select the window. For example, input 3 and press "WIN".
3. Press "AUTO" to start auto scan; press "AUTO" again to stop auto scan.

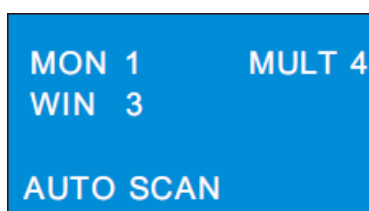

#### 4.8.8 Enable/Disable Light

##### To enable or disable light

1. Select the output. For example, input 1 and press "MON".
2. Select the window. For example, input 3 and press "WIN".
3. Press "LIGHT" to enable light; press "LIGHT" again to disable light.

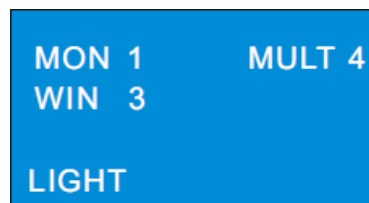

#### 4.8.9 Enable/Disable Wiper

##### To enable or disable wiper

1. Select the output. For example, input 1 and press "MON".
2. Select the window. For example, input 3 and press "WIN".
3. Press "WIPER" to enable wiper; press "WIPER" again to disable wiper.

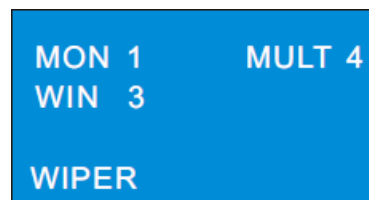

## 4.9 Record Playback

### 4.9.1 Start Playback

You can play back the record saved in the storage server of the ECMS/NVMS1000.

#### To play the record

1. Select the output. For example, input 1 and press "MON".
2. Select the window. For example, input 3 and press "WIN".
3. Press  key to play the record.

### 4.9.2 Pause Playback

When the record is in playing mode in the current window, press the pause key to pause playback.

1. Select the output. For example, input 1 and press "MON".
2. Select the window. For example, input 3 and press "WIN".
3. Press  key to stop playback.



### 4.9.3 Play the Previous 30s

You may play the record of the previous 30 seconds. The setting steps are as follow.

1. Select the output. For example, input 1 and press "MON".
2. Select the window. For example, input 3 and press "WIN".
3. Press  key to play the record of the previous 30 seconds.

### 4.9.4 Play the Next 30s or Frame

When the record is in playing mode in the current window, you may play the record of the next 30 seconds. When the record is in pause mode in the current window, you may play the next frame. The setting steps are as follow.

1. Select the output. For example, input 1 and press "MON".
2. Select the window. For example, input 3 and press "WIN".
3. When the record is in playing mode, press  key to play the record of the next 30 seconds. When the record is in pause mode, press  key to play the next frame.

### 4.9.5 Stop Playback

When the record is in playing or pause mode, you may stop playback. The setting steps are as follow.

1. Select the output. For example, input 1 and press "MON".
2. Select the window. For example, input 3 and press "WIN".
3. Press  key to stop playback.

## 5.1 View Information

You may check the keyboard, model, SN, current mode, version, date, local IP, subnet mask and so on by pressing "INFO" key on the keyboard. Check the next page of the information by moving the joystick down.

Information	Information	Information	Information
Keyboard: 01	Model: xxx SN: xxx	Current Mode: Platform Mode	Vers: 1.0.1beta5 Date: 2016041904

Information	Information	Information	Information
Local IP 192.168.1.201	Subnet mask: 255.255.255.0	Default GW: 192.168.1.1	DNS server: 8.8.8.8

Information	Information	Information	Information
Alternate DNS: 4.4.4.4	HTTP Port: 4000	Platform IP: 192.168.1.100	Platform Port: 56789

## 5.2 Lock

You can lock the keyboard by pressing "LOCK" key. Input the password (the default password is 8888) to unlock the keyboard.

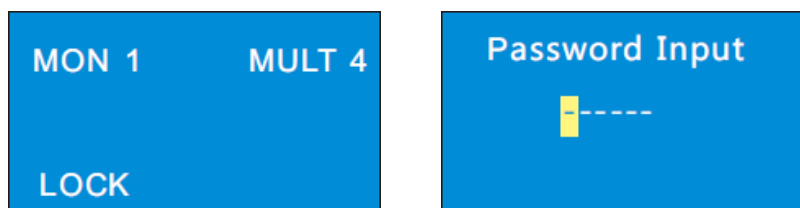

When the keyboard is locked, all keys except digital keys on the keyboard are unavailable until you input the password to unlock the keyboard.

Tips: After inputting wrong password for more than 3 times you can reset password by answering the security questions set by yourself.

## 6.1 Web Access

In order to view the keyboard from a network it may be connected to a LAN or internet. The network setup should be done accordingly.

- ① The keyboard shall be powered on and connected to the network. Please see [2.5 Local IP Setup](#) for details.
- ② Set the local IP address and HTTP port. The default local IP address is [192.168.001.201](#) and the default HTTP port is [4000](#). You shall add the port number when typing IP address in IE address blank as [http://192.168.001.201:4000](#) into IE browser.
- ③ Enter the password in the subsequent window (the default password is 8888).

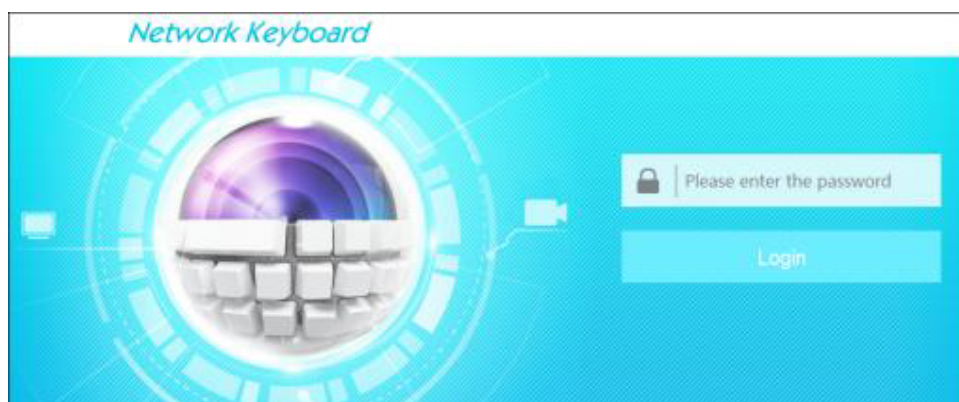

- ❖ Please make sure the IP address of the IE client is in the same local network as that of the keyboard. If the IP address of the keyboard is 192.168.001.201, the IP address of the IP client must be 192.168.001.XXX.
- ❖ Some models may be searched by IP-Tool. Make sure the PC and keyboard are connected to the LAN and double click the IP-Tool icon to run this software. Then the keyboard can be searched; if the keyboard can't be searched, please check whether the PC and the keyboard are connected to the network or not. Double click the keyboard in IP-Tool and the system will pop up the IE browser to connect to the keyboard.

You can check the system information. Click "logout" in the top-right corner and log out the IE client.



**Network Keyboard** Logout | System Information

**Maintenance**  
Upgrade

**System Information**

**Keyboard Information**

Keyboard SN:	Keyboard ID:	01
Software Version: 1.1.0	Software Date:	201605231059
Keyboard Model:	Language:	English

**Local Network Information**

IP Address:	192.168.16.201	
Subnet Mask:	225.225.225.0	GateWay: 192.168.16.1
Preferred DNS:	8.8.8.8	Alternate DNS: 4.4.4.4
HTTP Port :	4000	

## 6.2 Upgrade

Get the software from your vendor when there is a new software version.

1. Click "Browse" button to select the save path of the upgrade file.
2. Click "Upgrade server firmware" to start upgrading the application program.
3. After successfully update the software, the device will restart automatically.

**Network Keyboard** Logout | System Information

**Maintenance**  
Upgrade

Upgrade

Please select the upgrading file:   ,and click

Note: The upgrading process will take a few minutes. The device will automatically reboot after the upgrade is complete.

**Notice:** You can't disconnect to PC or close the keyboard during upgrade.

# 7 Specifications

<b>Local</b>	Local Display	LCD
	Joystick	Four-dimensional
	Key	Four functional areas
<b>Network</b>	LAN	RJ45 10/100M×1
	Control Mode	Platform mode/ PTZ mode
<b>Serial Port</b>	RS485	RS485 ×1
	Baudrate	1200bps, 2400bps, 4800bps, 9600bps, 19200bps
<b>Others</b>	Power	DC12V
	Power Consumption	≤8W
	Working Temperature	-10°C~ +60°C
	Working Humidity	10%--90%
	Dimension	420 (L) ×260(W)×170(H)mm
	Weight	2.8kg

Digital number/ alphabet input rules are listed in the following table.

Key	The relationship between the frequency of key-press and input display								
	once	twice	three times	four times	five times	six times	seven times	eight times	nine times
1	1	,	.						
2	2	A	B	C	a	b	c		
3	3	D	E	F	d	e	f		
4	4	G	H	I	g	h	i		
5	5	J	K	L	j	k	l		
6	6	M	N	O	m	n	o		
7	7	P	Q	R	S	p	q	r	s
8	8	T	U	V	t	u	v		
9	9	W	X	Y	Z	w	x	y	z
0	0	blank							



**AVYCON**<sup>®</sup>



**AVYCON**<sup>®</sup>

Copyright © AVYCON. All rights reserved. Specifications and pricing are subject to change without notice.

**phone:** 949-752-7606

**email:** [info@avycon.com](mailto:info@avycon.com)

**social:** [@avycon\\_aivo](#)

**website:** [avycon.com](http://avycon.com)